

Alpha® 4010 Dock

Specification Sheet

Issue 1.3

18/02/2021

Alpha® 4010 Dock

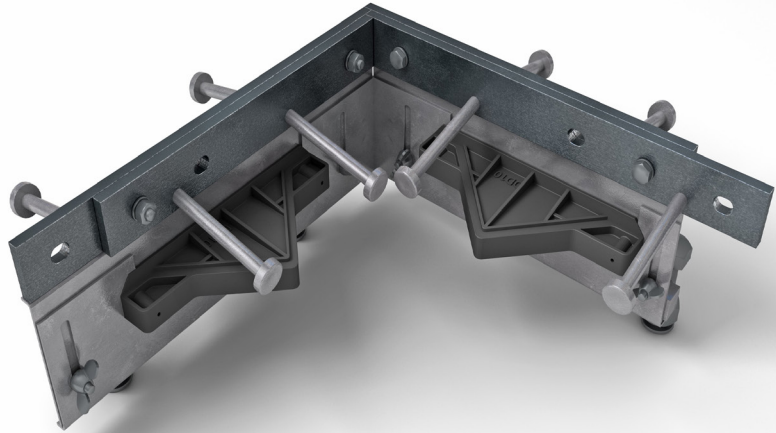

Alpha® 4010 Dock

10mm x 100mm shear studs anchor Alphadock to concrete

10mm wide cold drawn, square edge steel* provides joint arris armouring

Sheet steel formwork

Frangible fixing systems

**Universal Extension to suit slab depths 150-200

Plat dowel and debond sleeve provides load transfer across joints

* Also available in electro-galvanised steel and stainless steel
** Other fixed heights are available
Please note Alpha 4010 Docks are supplied as a pair

Alpha® 4010 Dock

Specification Sheet Issue 1.3
18/02/2021

manufacturing tolerances

Length	±2.0mm	Height	±1mm	Straightness	±0.5mm/600mm
---------------	--------	---------------	------	---------------------	--------------

dimensions of Alpha® 4010 Dock

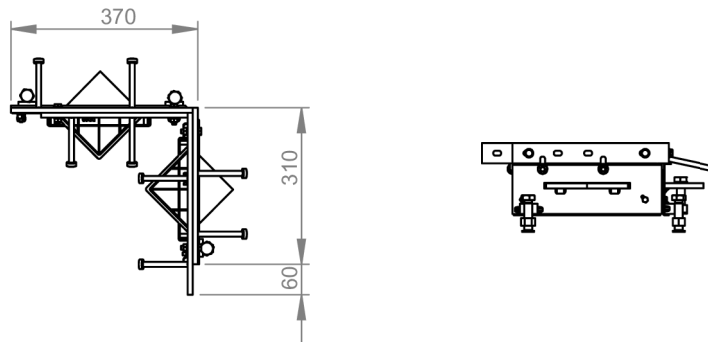

Dimensions in mm

dimensions and weight of Alpha® 4010 Dock

Accessory	Width (mm)	Length (mm)	Single Weight (kg)	Number Per Bundle	Bundle Weight (kg)
Dock (pair)	370	370	18	14	284

Typical height and length values shown only.

materials

Component	Material
Joint arris armouring (4010)	EN 10277-1:2018 S235JRC
Sheet steel formwork	BS EN 1030:2006 DC01
Shear stud	EN ISO 13918 :2017 S235J2
Plate dowel	BS EN 10025-2:2004 S275JRG2
Plate dowel sleeve	HDPP