

Permaban Eclipse®

Specification Sheet
Issue 3.9
01/09/2024

Permaban Eclipse®



Permaban Eclipse®

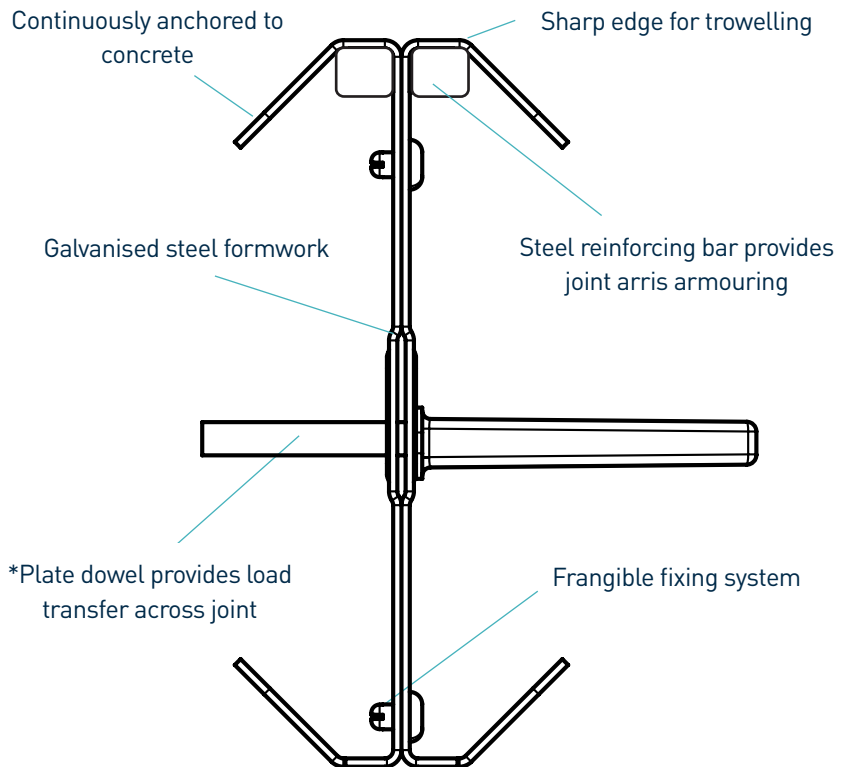

*Dowels available in thicknesses of 6mm, 8mm and 10mm

Permaban Eclipse®

Specification Sheet Issue 3.9
01/09/2024

manufacturing tolerances

Length ±2.0mm

Height ±1mm

Straightness ±0.5mm/600mm

dimensions of Permaban Eclipse®

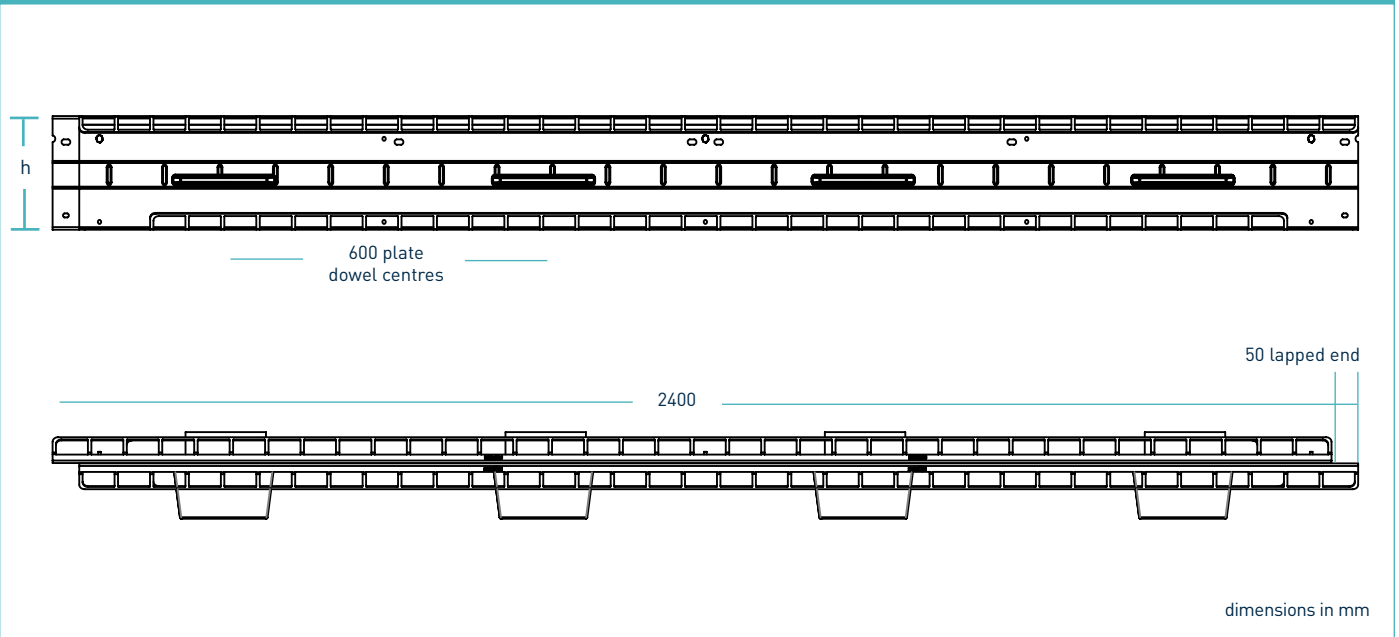

dimensions and weight of Permaban Eclipse®

Nominal Slab Depth (mm)	Joint Height, h (mm)	Dowel Size (mm)	Dowel Centres (mm)	Length (mm)	Single Joint Weight (kg)	Number Per Bundle	Bundle Weight (kg)
150	125	151 x 120 x 8	600	2400	17.5	75	1437.5
175	150				19.5	65	1392.5
200	175				21.5	52	1243
225	200				23.5	52	1347
250	225				25.5	39	1119.5

Typical height and length values shown only. Weight values shown are based on Permaban Eclipse® including TD8 dowels and are approximate.

materials

Component	Material
Joint arris armouring	EN 10346:2015 Dx51D+Z & EN 10025-2:2004 S275JR
Plate dowel	EN 10025-2:2004 S275JR
Plate dowel sleeve	HDPP

Permaban Eclipse®

Specification Sheet Issue 3.9
01/09/2024

theoretical calculated ultimate loads at failure of dowel or concrete

(For typical slabs, 40N/mm² concrete and 20mm joint opening)

Slab Depth (mm)	Dowel Type	Unreinforced Slab	
		Bending (kN/m)	Bursting (kN/m)
150	TD6	30.2	53.0
	TD8	30.2	86.2
	TD10	30.2	123.0
175	TD6	38.7	53.0
	TD8	38.7	86.2
	TD10	38.7	123.0
200	TD6	48.3	53.0
	TD8	48.3	86.2
	TD10	48.3	123.0
225	TD6	58.8	53.0
	TD8	58.8	86.2
	TD10	58.8	123.0
250	TD6	70.3	53.0
	TD8	70.3	86.2
	TD10	70.3	123.0
275	TD6	82.9	53.0
	TD8	82.9	86.2
	TD10	82.9	123.0
300	TD6	84.2	53.0
	TD8	84.2	86.2
	TD10	84.2	123.0
325	TD6	79.5	53.0
	TD8	79.5	86.2
	TD10	79.5	123.0

Permaban Eclipse[®]

Specification Sheet Issue 3.9
01/09/2024

Ultimate load (kN/m)

This table shows the load at failure in bursting (failure of the concrete) and bending (failure of the dowel) for a joint opening of 20mm - larger joint openings can be accommodated. The ultimate load has been calculated in accordance with TR34 4th Edition. Dowel positions taken at mid depth of slab. For more detailed analysis please contact RCR Flooring Products Ltd.

*All design calculations should be verified by a suitably qualified structural engineer.

compatible dowel systems

