

Permaban Signatureslide

Ficha de especificaciones
Versión 1.4
12/12/2019

Permaban Signatureslide



Permaban Signatureslide

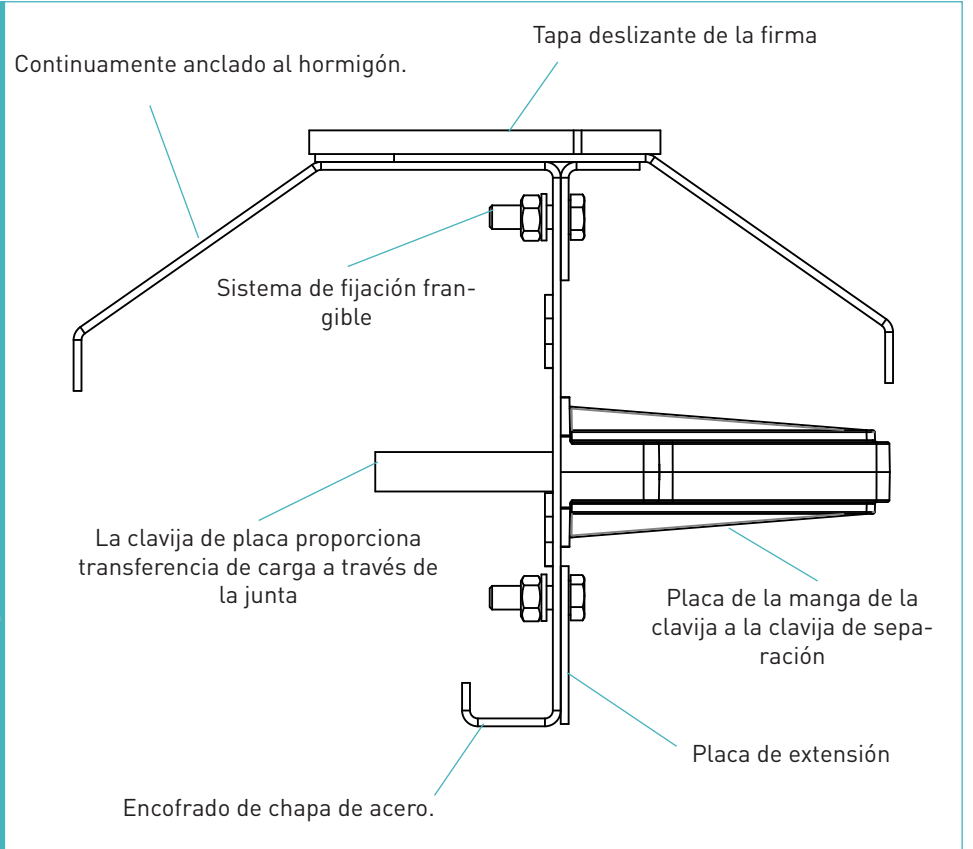

Permaban SignatureSlide

Ficha de especificaciones Versión 1.4
12/12/2019

tolerancias de fabricación

Longitud ±2.0mm

Altura ±1mm

Rectitud ±0.5mm/600mm

dimensiones de Permaban SignatureSlide

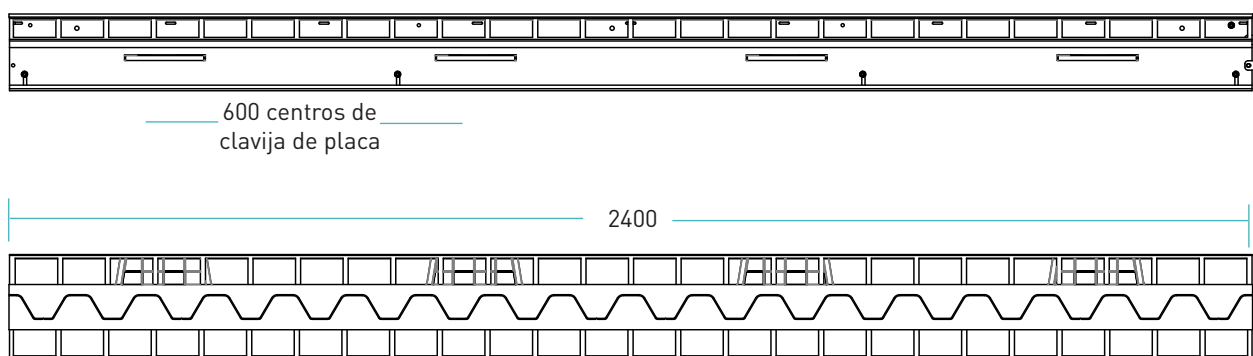

dimensiones en mm

dimensiones y peso de Permaban SignatureSlide

Profundidad nominal losa (mm)	Altura junta, h (mm)	Tamaño de conector (mm)	Distancia entre conectores (mm)	Longitud (mm)	Peso de una sola articulación (kg)	Cantidad por lote	Peso del lote (kg)
150	130	151 x 120 x 10	600	2400	29.47	40	1299 kg
170	150				30.47	32	1095 kg
200	180				34.47	32	1127 kg

Sólo se muestran los valores típicos de altura y longitud. Los valores de peso mostrados se basan en permaban SignatureSlide, incluidas las clavijas TD10 y TD8, y son aproximados.

materiales

Componente	Materiales
Armado de arista de junta	BS 070M20
Encofrado en plancha de acero	EN 10130: 2006 DC01
Clavija de placa	BS EN 10025-2:2004 S275JR min 410 N/mm ² tensile strength
Manguito de placa	HDPP

Permaban SignatureSlide

Fiche technique Édition 1.4
12/12/2019

Cargas teóricas calculadas de última generación en caso de falla de clavija u hormigón

(para losas típicas, concreto de 40N / mm ² y abertura de junta de 200 mm)		Losas no reforzadas	
Profondeur de la dalle (mm)	Tipo de clavija	Rotura del hormigón (kN/m)	Flexión del conector
150	TD8	31.2	87.2
	TD10	31.2	124.7
175	TD8	40.0	87.2
	TD10	40.0	124.7
200	TD8	49.9	87.2
	TD10	49.9	124.7
225	TD8	60.7	87.7
	TD10	60.7	124.7
250	TD8	72.4	87.7
	TD10	72.4	124.7
275	TD8	85.6	87.7
	TD10	85.6	124.7
300	TD8	86.9	87.7
	TD10	86.9	124.7

Carga máxima (kN/m)

Permaban joints are compatible with all grades of concrete in accordance with EN206. This table shows the load at failure in bursting (failure of the concrete) and bending (failure of the dowel) for a joint opening of 20mm - larger joint openings can be accommodated. The ultimate load has been calculated in accordance with TR34 4th Edition. Dowel position taken at mid depth of slab. For more detailed analysis please contact RCR Flooring Products Ltd.

*All design calculations should be verified by a suitably qualified structural engineer.

